



5mm pitch 45° rising clamp terminal blocks

Product overview

- 2 and 3 pole interlocking
- Professional rising clamp terminals
- Low profile 45° mounting
- Moulded in green UL94-V0 flame retardant PA66
- Cable acceptance VDE - 0.6-2.5mm² (22-10AWG)
- Cable acceptance UL - 0.6-1.6mm² (22-14AWG)
- Guided pin alignment
-   approved

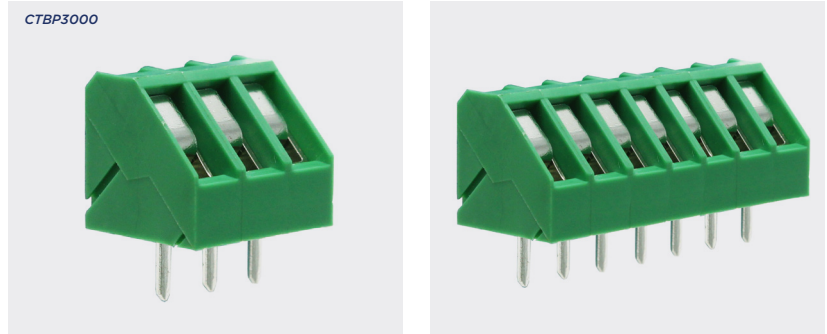

SPECIFICATION		PART NO.	POLES	LENGTH
Rating	UL=15A/300V, VDE=24A/300V	CTBP3000/2	2	10mm
Insulation resistance	500M Ω/500V	CTBP3000/3	3	15mm
Withstand voltage	AC2000V/1min	CTBP3000/4	4	20mm
Contact resistance	20mΩ (max)	CTBP3000/5	5	25mm
Working temperature	-40°C to +105°C	CTBP3000/6	6	30mm
Moulding	UL94-V0 flame retardant PA66	CTBP3000/7	7	35mm
Pin/terminal	Tin plated brass	CTBP3000/8	8	40mm
Rising clamp	Brass, nickel plated	CTBP3000/9	9	45mm
Screw/torque	M2.5 steel, zinc plated 0.4Nm	CTBP3000/10	10	50mm
Recommended PCB hole size	ø1.5mm	CTBP3000/11	11	55mm
		CTBP3000/12	12	60mm

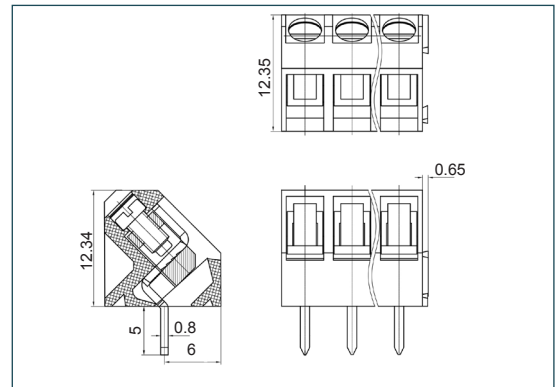

KEY FEATURES

45 Degree cable entry | Interlock mechanism | Professional rising clamp

